

# Use & Care

G U I D E

## Standard-Cleaning Gas Ranges

A Note to You .....	2
Range Safety .....	3
Parts and Features ...	5
Using Your Range .....	6
Caring for Your Range .....	17
Troubleshooting .....	23
Requesting Assistance or Service .....	25
Index .....	27
Warranty .....	28

**TO THE INSTALLER: PLEASE LEAVE THIS INSTRUCTION BOOK WITH THE UNIT.**  
**TO THE CONSUMER: PLEASE READ AND KEEP THIS BOOK FOR FUTURE REFERENCE.**

MODELS FGP325G FGP335G

PART NO. 8053428

**ROPER**<sup>®</sup>

Home Appliances

4-98

# A NOTE TO YOU

Thank you for buying a ROPER® appliance.

Your ROPER range gives you all the functionality of name brand appliances at a value price. To ensure that you enjoy years of trouble-free operation, we developed this Use and Care Guide. It is full of valuable information about how to operate and maintain your appliance properly and safely. Please read it carefully.

Also, please complete and mail the **Product Registration Card** provided with your appliance. The card helps us notify you about any new information on your appliance.

Please record your model's information.

Whenever you call to request service for your appliance, you need to know your complete model number and serial number. You can find this information on the model and serial number label/plate (see the diagram in the "Parts and Features" section).

Please also record the purchase date of your appliance and your dealer's name, address, and telephone number.

Model Number \_\_\_\_\_

Serial Number \_\_\_\_\_

Purchase Date \_\_\_\_\_

Dealer Name \_\_\_\_\_

Dealer Address \_\_\_\_\_

Dealer Phone \_\_\_\_\_

**Keep this book and the sales slip together in a safe place for future reference. It is important for you to save your sales receipt showing the date of purchase. Proof of purchase will assure you of in-warranty service.**

**WARNING: If the information in this manual is not followed exactly, a fire or explosion may result causing property damage, personal injury or death.**

**- Do not store or use gasoline or other flammable vapors and liquids in the vicinity of this or any other appliance.**

**- WHAT TO DO IF YOU SMELL GAS**

- Do not try to light any appliance.
- Do not touch any electrical switch; do not use any phone in your building.
- Immediately call your gas supplier from a neighbor's phone. Follow the gas supplier's instructions.
- If you cannot reach your gas supplier, call the fire department.

**- Installation and service must be performed by a qualified installer, service agency or the gas supplier.**

# RANGE SAFETY

## Your safety and the safety of others is very important.

We have provided many important safety messages in this manual and on your appliance. Always read and obey all safety messages.



This is the safety alert symbol.

This symbol alerts you to hazards that can kill or hurt you and others.

All safety messages will be preceded by the safety alert symbol and the word "DANGER" or "WARNING." These words mean:

### **⚠ DANGER**

You will be killed or seriously injured if you don't follow instructions.

### **⚠ WARNING**

You can be killed or seriously injured if you don't follow instructions.

All safety messages will identify the hazard, tell you how to reduce the chance of injury, and tell you what can happen if the instructions are not followed.

## **⚠ WARNING**



### Tip Over Hazard

A child or adult can tip the range and be killed.

Connect anti-tip bracket to rear range foot.

Reconnect the anti-tip bracket, if the range is moved.

See the installation instructions for details.

Failure to follow these instructions can result in death or serious burns to children and adults.

### Anti-Tip Bracket

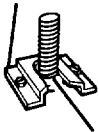

Range Foot

Making sure the anti-tip bracket is installed:

- Slide range forward.
- Look for the anti-tip bracket securely attached to floor.
- Slide range back so rear range foot is under anti-tip bracket.

continued on next page

## IMPORTANT SAFETY INSTRUCTIONS

**WARNING:** To reduce the risk of fire, electrical shock, injury to persons, or damage when using the range, follow basic precautions, including the following:

- **WARNING – TO REDUCE THE RISK OF TIPPING OF THE RANGE, THE RANGE MUST BE SECURED BY PROPERLY INSTALLED ANTI-TIP DEVICES. TO CHECK IF THE DEVICES ARE INSTALLED PROPERLY, SLIDE RANGE FORWARD, LOOK FOR ANTI-TIP BRACKET SECURELY ATTACHED TO FLOOR, AND SLIDE RANGE BACK SO REAR RANGE FOOT IS UNDER ANTI-TIP BRACKET.**
- **CAUTION –** Do not store items of interest to children in cabinets above a range or on the backguard of a range –children climbing on the range to reach items could be seriously injured.
- **Proper Installation –** The range, when installed, must be electrically grounded in accordance with local codes or, in the absence of local codes, with the *National Electrical Code, ANSI/NFPA 70*. Be sure the range is properly installed and grounded by a qualified technician.
- This range is equipped with a three-prong grounding plug for your protection against shock hazard and should be plugged directly into a properly grounded receptacle. Do not cut or remove the grounding prong from this plug.

- Disconnect the electrical supply before servicing the appliance.
- Never Use the Range for Warming or Heating the Room.
- Injuries may result from the misuse of appliance doors or drawers such as stepping, leaning, or sitting on the doors or drawers.
- Maintenance – Keep range area clear and free from combustible materials, gasoline, and other flammable vapors and liquids.
- Storage in or on the Range – Flammable materials should not be stored in an oven or near surface units.
- Top burner flame size should be adjusted so it does not extend beyond the edge of the cooking utensil.

For self-cleaning ranges –

- Before Self-Cleaning the Oven – Remove broiler pan and other utensils. Wipe off all excessive spillage before initiating the cleaning cycle.

**– SAVE THESE INSTRUCTIONS –**

# PARTS AND FEATURES

(Model FGP335G shown)

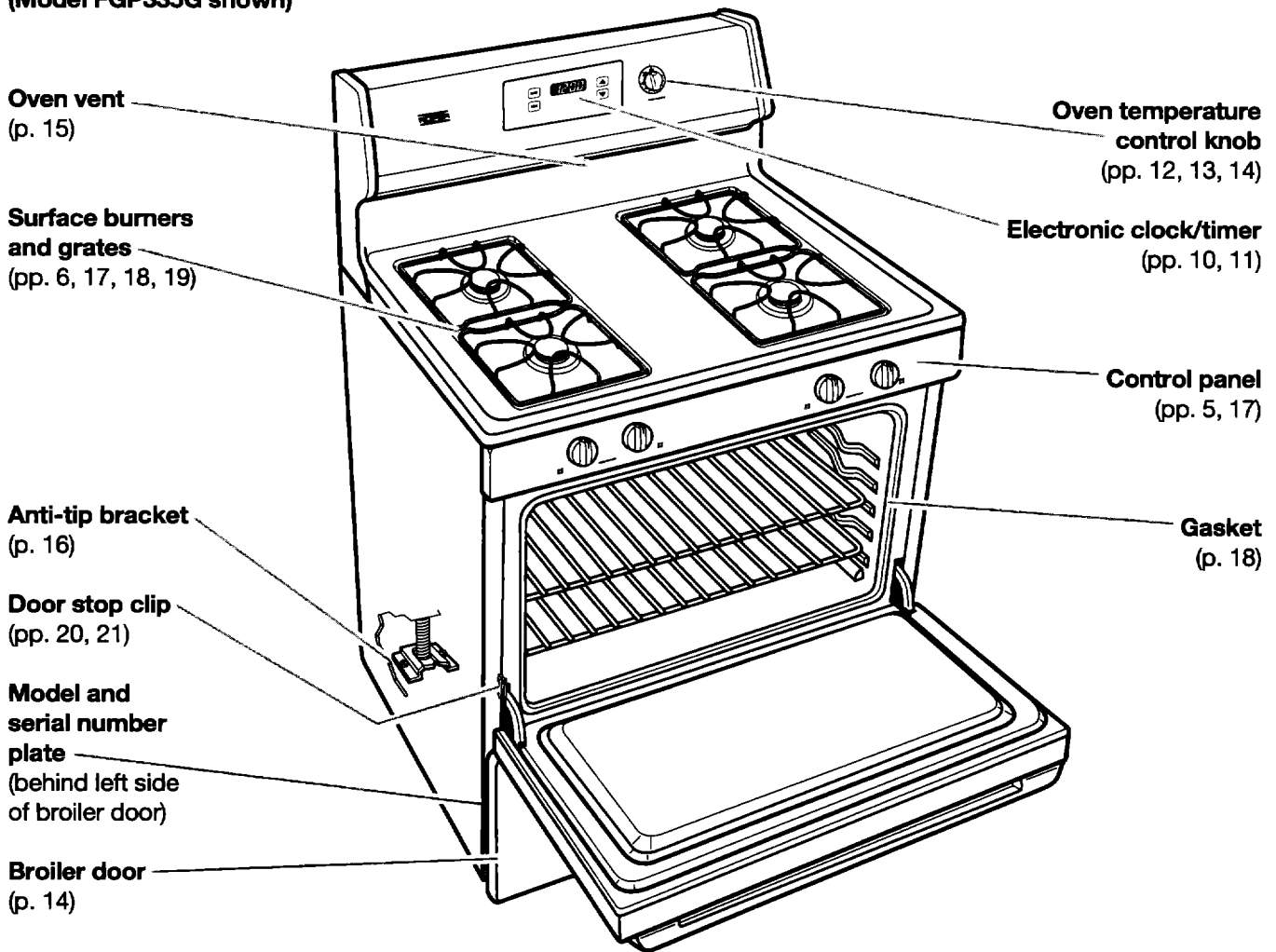

## CONTROL PANEL



# USING YOUR RANGE

## USING THE SURFACE BURNERS

### ⚠ WARNING



#### Fire Hazard

Do not let the burner flame extend beyond the edge of the pan.

Turn off all controls when not cooking.

Failure to follow these instructions can result in death or fire.

### Using the control knobs

Your range comes with electric ignitors. Electric ignitors automatically light the burners each time you turn the control knobs to LIGHT.

- Place a filled pan on the burner grate before turning on the surface burner. Do not operate a burner for extended periods of time without having cookware on the grate.
- Push in the control knob and turn it **counter-clockwise** to the LIGHT position. The clicking sound is the ignitor sparking. Make sure the burner has lit.

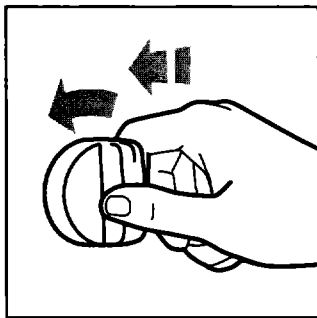

● To stop the clicking sound after the burner lights, turn the control knob to the cook setting you want. You can set the control knob any-

where between HIGH and LOW.

**NOTE:** All four electric ignitors will click at the same time. However, the burner with the control knob turned to LIGHT is the one that will ignite.

### Burner heat settings

Use the following chart as a guide.

SETTING	RECOMMENDED USE
LIGHT	● To light the burner.
HIGH	● To start food cooking. ● To bring liquid to a boil.
Mid-range (between HIGH and LOW)	● To hold a boil. ● To fry chicken or pancakes. ● For gravy, pudding, and icing. ● To cook large amounts of vegetables.
LOW	● To keep food warm. ● To melt chocolate or butter. ● To simmer.

**NOTE:** Do not leave empty cookware, or cookware which has boiled dry, on a hot surface burner. The cookware could overheat, causing damage to the cookware or cooking product.

### Easy ways to save energy

- To help shorten your cooking time, use the least amount of liquid possible.
- Preheat your pots and pans only when recommended and for the shortest time possible.
- Start your food on a higher heat setting, then turn the control to a lower setting to finish cooking.

## USING THE SURFACE BURNERS (CONT.)

### In case of a prolonged power failure

You can manually light surface burners. Hold a lit match near a burner and turn the control knob to the LIGHT position. After the burner lights, turn the control knob to the setting you want.

### Home canning information

The large diameter of most water-bath or pressure canners combined with high heat settings for long periods of time can cause damage to the cooktop.

#### To protect your range:

- For best results, use a canner which can be centered over the surface burner.
- Do not place your canner on 2 surface burners at the same time.
- Start with hot water. This reduces the time the control is set on high. Reduce the heat setting to the lowest position needed to maintain a boil or required pressure levels in a pressure canner.

- Refer to your canner manual for specific instructions.

For up-to-date information on canning, contact your local U.S. Government Agricultural Department Extension Office or companies who manufacture home canning products.

### Using the right cookware makes a big difference

- The pan should have a flat bottom, straight sides, and a well-fitting lid.
- Choose medium to heavy gauge (thickness) cookware.
- The pan material (metal or glass) affects how quickly and evenly the pan heats.
- When using glass or ceramic cookware, check to make sure it is suitable for use on surface burners.
- To avoid tipping, make sure pots and pans are centered on the grates.

## CHARACTERISTICS OF COOKWARE MATERIALS

The pan material affects how fast heat transfers from the surface cooking area through the pan material and how evenly heat spreads over the pan bottom. Choose pans that provide the best cooking results.

Aluminum	<ul style="list-style-type: none"> <li>• Heats quickly and evenly.</li> <li>• Use for all types of cooking.</li> <li>• Medium or heavy thickness is best for most cooking.</li> <li>• Used as a core or base in cookware to provide even heating.</li> </ul>
Cast iron	<ul style="list-style-type: none"> <li>• Heats slowly and evenly.</li> <li>• Good for browning and frying.</li> <li>• Maintains heat for slow cooking.</li> <li>• Can be coated with porcelain enamel.</li> </ul>
Ceramic or ceramic glass	<ul style="list-style-type: none"> <li>• Heats slowly and unevenly.</li> <li>• Use on low to medium settings.</li> <li>• Follow manufacturer's instructions.</li> </ul>
Copper	<ul style="list-style-type: none"> <li>• Heats very quickly and evenly.</li> <li>• Used as a core or base in cookware to provide even heating.</li> </ul>
Earthenware	<ul style="list-style-type: none"> <li>• Can be used for cooktop cooking if recommended by the manufacturer.</li> <li>• Use on low settings.</li> </ul>
Porcelain enamel-on-steel or enamel-on-cast iron	<ul style="list-style-type: none"> <li>• See cast iron and stainless steel.</li> </ul>
Stainless steel	<ul style="list-style-type: none"> <li>• Heats quickly but unevenly.</li> <li>• A core or base of aluminum or copper on the cookware provides even heating.</li> <li>• Can be coated with porcelain enamel.</li> </ul>

# USING THE OVEN

## Positioning racks and pans

Place the oven racks where you need them before turning on the oven.

- To move a rack, pull it out to the stop position, raise the front edge and lift it out.
- Be sure the rack(s) is level.
- Use pot holders or oven mitts to protect your hands if rack(s) must be moved while the oven is hot.
- For best performance, cook on one rack. Place the rack so the top of the food will be centered in the oven.
- When cooking with two racks, arrange the racks on the 2nd and 4th rack guides. Two sheets of cookies may be baked if sheets are switched at approximately three quarters of the total bake time. Increase baking time, if necessary.
- For best results allow 2 inches of space around each pan and between pans and oven walls.

## Where to place pans:

WHEN YOU HAVE	PLACE
1 pan	In center of the oven rack.
2 pans	Side by side or slightly staggered.
3 or 4 pans	In opposite corners on each oven rack. Stagger pans so no pan is directly over another.

## Extra oven rack position (roasting rack)

Use this rack position when roasting food too large to be placed on the first rack position.

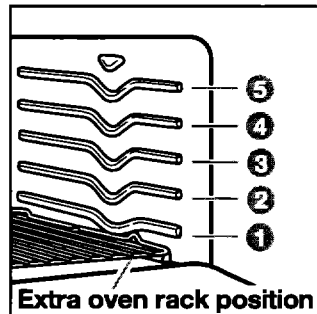

**For proper roasting, follow these guidelines:**

- To avoid spillage, remove food before pulling out the rack.
- Tilt the rack up at the front before pulling it over the door.

- Use an adequate amount of liquid in the pan (meat juices or water) so your food does not get overdone.



# USING ALUMINUM FOIL

- Use aluminum foil to catch spillovers from pies or casseroles by placing foil on the oven rack below. Foil should be turned up at edges and be at least 1 inch larger than dish.

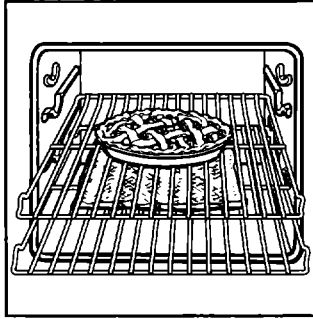

- Do not cover the entire rack with aluminum foil. It will reduce air circulation and give you poor cooking results.

- Do not line the oven bottom with foil or other liners. It could affect the oven surface as well as the quality of your baking.
- Place tent-shaped foil loosely over meat or poultry to slow down surface browning for long term roasting. Remove foil for the last 30 minutes.
- Use narrow strips of foil to shield piecrust edges if browning too quickly.

# BAKEWARE CHOICES

Baking performance is affected by the type of bakeware used. Use the bakeware size recommended in the recipe.

BAKEWARE TYPE	BEST USED FOR	GUIDELINES
Light colored aluminum	<ul style="list-style-type: none"> <li>• Light golden crusts</li> <li>• Even browning</li> </ul>	<ul style="list-style-type: none"> <li>• Use temperature and time recommended in recipe.</li> </ul>
Dark aluminum and other bakeware with dark, dull, and/or non-stick finish	<ul style="list-style-type: none"> <li>• Brown, crisp crusts</li> </ul>	<ul style="list-style-type: none"> <li>• May reduce baking temperature 25°F.</li> <li>• Use suggested baking time.</li> <li>• Use temperature and time recommended in recipe for pies, breads, and casseroles.</li> <li>• Place rack in center of oven.</li> </ul>
Ovenproof glassware, ceramic glass, or ceramic	<ul style="list-style-type: none"> <li>• Brown, crisp crusts</li> </ul>	<ul style="list-style-type: none"> <li>• May reduce baking temperature 25°F.</li> </ul>
Insulated cookie sheets or baking pans	<ul style="list-style-type: none"> <li>• Little or no bottom browning</li> </ul>	<ul style="list-style-type: none"> <li>• Place in the bottom third of oven.</li> <li>• May need to increase baking time.</li> </ul>
Stainless steel	<ul style="list-style-type: none"> <li>• Light, golden crusts</li> <li>• Uneven browning</li> </ul>	<ul style="list-style-type: none"> <li>• May need to increase baking time.</li> </ul>
Stoneware	<ul style="list-style-type: none"> <li>• Crisp crusts</li> </ul>	<ul style="list-style-type: none"> <li>• Follow manufacturer's instructions.</li> </ul>

# THE ELECTRONIC TIME-OF-DAY (TOD) CLOCK/TIMER (MODEL FGP335G)

Electronic display

**Clock pad** (p. 10)

**Oven timer pad** (p. 11)

**Increase pad** (p. 10, 11)

**Decrease pad** (p. 10, 11)

### Display/clock

- **When you first plug in the range**, the entire display appears followed by a flashing time-of-day. If, after you set the clock (see "Setting the clock" section), the display flashes, your electricity was off for a while. Reset the clock.
- **When you are not using the oven**, the display shows the time of day.
- **When showing the time of day**, the display will show the hour and minutes.
- **When you are using the timer**, the display will show seconds for time less than 1 minute, minutes for time less than 1 hour, and hours and minutes for time over 1 hour. The timer indicator will be lit when in the timer mode.

## SETTING THE CLOCK (MODEL FGP335G)

<p><b>1.</b> Press CLOCK. The colon flashes during clock programming.</p>	<p><b>PRESS</b></p>	<p><b>YOU SEE</b></p>
<p><b>2.</b> Set the time. Press the "up" (▲) or "down" (▼) pad(s) until the correct time shows on the display. <b>NOTE:</b> Press a pad briefly to change time by a small amount. Press and hold a pad to change time by 10 minute increments.</p>	<p><b>PRESS</b></p> 	<p><b>YOU SEE</b></p>
<p><b>3.</b> Press CLOCK again to start the clock. The colon stops flashing when the clock is active.</p>	<p><b>PRESS</b></p>	<p><b>YOU SEE</b></p>

# USING THE ELECTRONIC TIMER (MODEL FGP335G)

The timer does not start or stop the oven. It works like a kitchen timer. It can be set in hours and minutes up to 12 hours, 59 minutes. The timer will display minutes for settings under 1 hour and hours and minutes for settings over 1 hour. You will hear four 1-second tones when the set time is up.

**NOTE:** To display the time of day while the timer is counting down, press CLOCK. Time of day will be displayed for 5 seconds before returning to the timer countdown.

1. Press TIMER. The colon flashes during timer programming.

PRESS



YOU SEE



2. Set the interval to be timed.

Press the "up" (▲) or "down" (▼) pad(s) until the correct time shows on the display.

The timer will begin counting down 5 seconds after the time is set.

PRESS



YOU SEE



3. When there is 1 minute of time remaining, you will hear one tone. The display will then begin counting down in seconds.

When the timer countdown reaches zero, the display will show "End" and you will hear four 1-second tones.

YOU SEE



(display counts in seconds)

YOU SEE



## To return to time-of-day mode:

Press TIMER once.

PRESS



YOU SEE



(time of day)

## To cancel the timer:

Press TIMER twice while in the timer mode.

# BAKING/ROASTING

**IMPORTANT:** Do not attempt to light the oven burner during a power failure.

1. Place racks where you need them. For more information, see

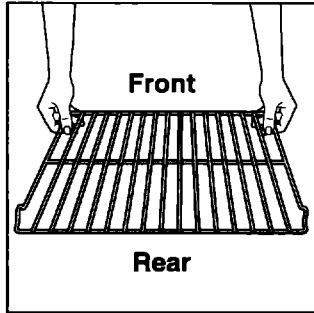

“Positioning racks and pans” in the “Using the oven” section.

2. Push in and turn the oven temperature control knob counterclockwise to the baking/roasting temperature you want. The oven burner will light by itself in 50-60 seconds.

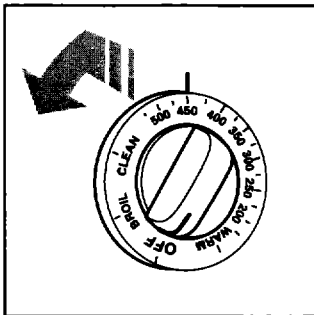

3. When baking, preheat the oven before putting food into it. During baking/roasting, the oven burner will turn on and off to keep the oven temperature at the selected setting.

**NOTE:** Do not place food directly on the oven door or the oven bottom. If you want, place the food on the rack at the extra rack position.

4. After baking/roasting, turn the oven temperature control knob clockwise to OFF.

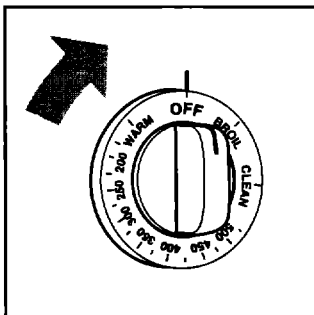

## Roasting meats and poultry

- For even cooking, place the meat on a rack in a shallow pan. This keeps the meat out of the drippings and allows the heat to circulate better.
- Use a meat thermometer for the most accurate doneness. Insert it so the tip is in the center of the largest muscle or thickest portion of the meat or poultry. Make sure the thermometer is not touching bone, fat, or the bottom of the pan.

## Saving energy

- To avoid loss of heat, open the oven door as little as possible.
- Use a timer to keep track of cooking time.
- Plan your meals for the most efficient use of the oven by cooking more than one food at a time, or baking while the oven is still hot after cooking a meal.

## Rack placement for specific foods:

FOOD	RACK POSITION
Frozen pies, large roasts, turkeys, angel food cakes	1st or 2nd rack guide from bottom
Bundt cakes, most quick breads, yeast breads, casseroles, meats	2nd rack guide from bottom
Cookies, biscuits, muffins, cakes, nonfrozen pies	2nd or 3rd rack guide from bottom

**NOTE:** For information on where to place your rack when broiling, see “Broiling guidelines” later in this section.

# ADJUSTING THE OVEN TEMPERATURE CONTROL

Although your new oven is properly adjusted to provide accurate temperatures, it may cook faster or slower than your old oven.

If you are not satisfied with the baking/roasting results, you can change the temperature calibration by following the steps below.

**NOTE:** DO NOT measure the oven temperature with a thermometer. Opening the oven door will lower the oven temperature and give you an incorrect reading. Also, the thermometer temperature reading will change as your oven cycles.

1. Make sure the oven temperature control knob is turned to the off position. Pull the knob straight off and flip it over.

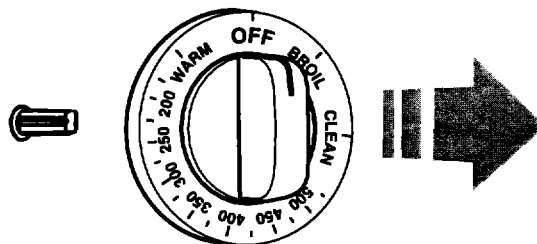

2. Loosen the locking screws inside the control knob.  
Note the position of the notches.

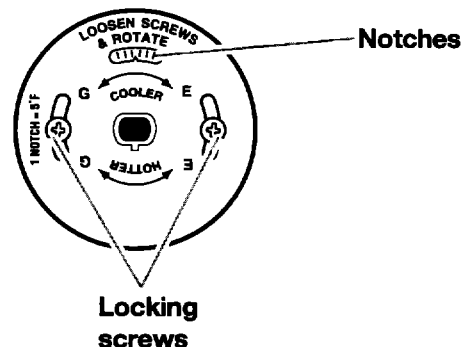

3. Adjust the temperature.

- **To lower the temperature**, hold the knob handle firmly and turn the skirt **counterclockwise** to move the tooth a notch to the "G" on the "COOLER" arrow.
- **To raise the temperature**, hold the knob handle firmly and turn the skirt **clockwise** to move the tooth a notch to the "G" on the "HOTTER" arrow.

Each notch equals about 5°F.

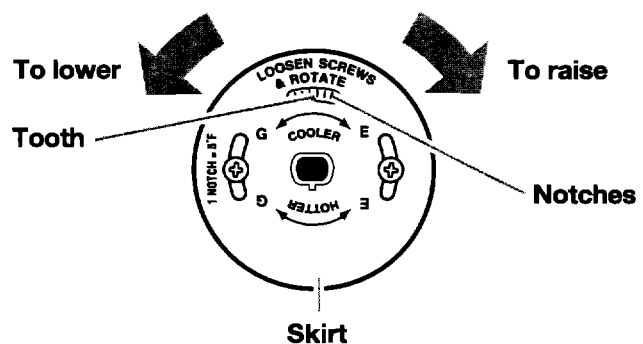

4. Tighten the locking screws and replace the control knob.

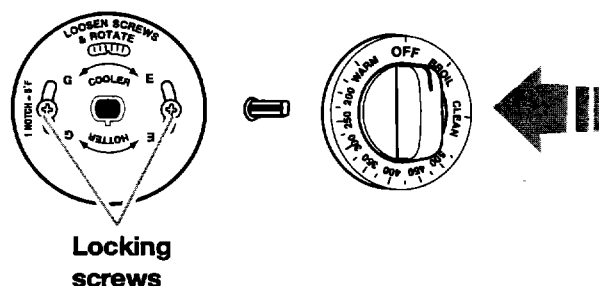

# BROILING

## Broiler pan and grid

The broiler is located below the oven door. Always broil with the broiler and oven doors closed.

**NOTES:**

- Do not step on or apply weight to the broiler door when it is open. This could damage the door.
- Do not preheat the broiler before using it, unless your recipe recommends it. Completely close the broiler door during broiling.

**1.** Open the broiler door. Pull out the broiler pan and grid.

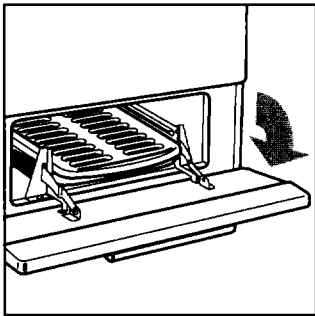

**2.** Place the grid on the broiler pan so grease can drain down into the lower part of the broiler pan.

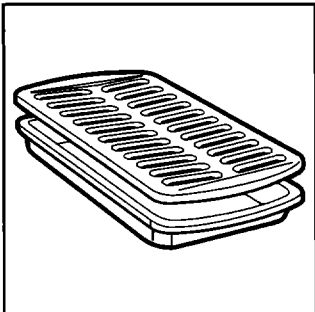

**3.** Before the broiler is turned on, place your food on the broiler pan. Then place the pan on the broiler bottom (Position 0) or one of the two other positions.

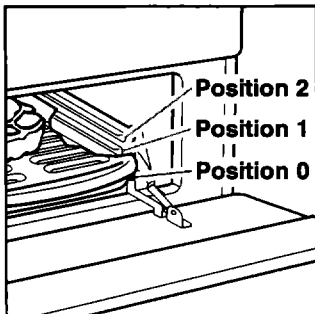

**4.** Close the broiler door.

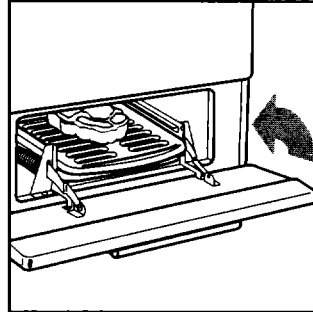

**5.** Push in and turn the oven temperature control knob counterclockwise to BROIL. The broiler will automatically light in 50-60 seconds.

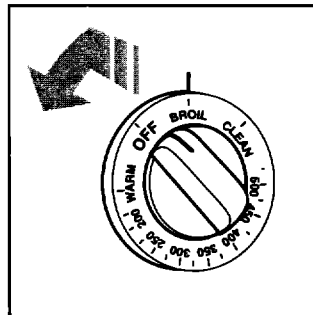

**6.** After broiling, turn the oven temperature control knob clockwise to OFF.

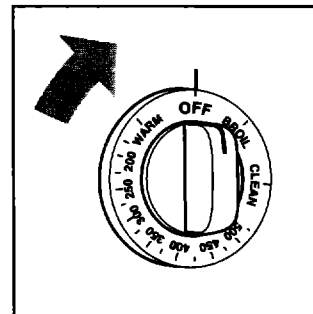

## **BROILING (CONT.)**

### **Broiling guidelines**

Recommended pan positions are numbered from bottom (0) to top (2) (see "Broiler pan and grid" earlier in this section.) For best results, place food 3 inches or more from the broil burner. **You should rotate the broiler pan back to the front at the same time you turn the foods.**

<b>MEAT</b>	<b>PAN POSITION</b>	<b>APPROXIMATE TIME (MINUTES)</b>	
		<b>SIDE 1</b>	<b>SIDE 2</b>
<b>Steak, 1" thick</b>	1		
medium-rare		10-12	5-6
medium		12-14	6-7
well-done		16-17	8-9
<b>Ground Meat Patties, ¾" thick, well-done</b>	1	11-13	6-7
<b>Pork Chops, 1" thick</b>	0	19-21	9-10
<b>Ham Slice, ½" thick, precooked</b>	1	6-8	3-4
<b>Frankfurters</b>	1	5-6	2-3
<b>Chicken</b>			
bone-in pieces	0	15-17	15-17
boneless breasts	1	11-13	11-13
<b>Fish, ½-¾" thick fillets</b>	1	7-8	3-4

Times are guidelines only and may need to be adjusted to individual tastes.

## **THE OVEN VENT**

Hot air and moisture escape from the oven through a vent that is near the middle of the backguard. The vent lets air circulate properly. Be careful not to block the vent, or you will get poor baking/roasting results.

**NOTE:** Never store plastics, paper, or other items that could melt or burn near the oven vent, or any of the surface burners.

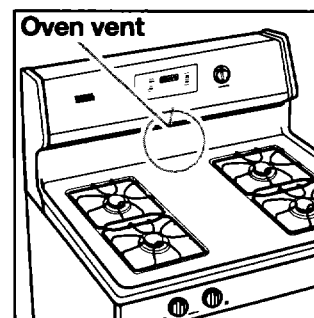

## THE ANTI-TIP BRACKET

The range will not tip during normal use. However, the range can tip if you apply too much force or weight to the open door without the anti-tip bracket fastened down properly.

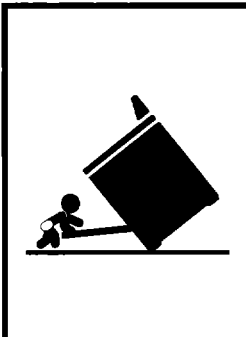

### **⚠ WARNING**

#### **Tip Over Hazard**

**A child or adult can tip the range and be killed.**

**Connect anti-tip bracket to rear range foot.**

**Reconnect the anti-tip bracket, if the range is moved.**

**See the installation instructions for details.**

**Failure to follow these instructions can result in death or serious burns to children and adults.**

#### **Anti-Tip Bracket**

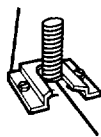

**Range Foot**

**Making sure the anti-tip bracket is installed:**

- **Slide range forward.**
- **Look for the anti-tip bracket securely attached to floor.**
- **Slide range back so rear range foot is under anti-tip bracket.**



# CARING FOR YOUR RANGE

	<b>!WARNING</b>
	<p><b>Explosion Hazard</b></p> <p>Do not store flammable materials such as gasoline near this appliance. Doing so can result in death, explosion, or fire.</p>

## CLEANING CHART

Before cleaning, always make sure all controls are off and the range is cool. Refer to instructions on all cleaning products before using them to clean your range.

PART	CLEANING METHOD	SPECIAL INSTRUCTIONS
<b>Control Knobs</b>	<ul style="list-style-type: none"> <li>• Soap and water</li> <li>• Dishwasher</li> </ul>	<ul style="list-style-type: none"> <li>• DO NOT use steel wool or abrasive cleaners.</li> <li>• Pull knobs straight away from control panel.</li> <li>• Wash, rinse and dry with soft cloth.</li> </ul>
<b>Control Panel</b>	<ul style="list-style-type: none"> <li>• Soap and water</li> <li>• Spray glass cleaner</li> </ul>	<ul style="list-style-type: none"> <li>• Wash, rinse and dry with soft cloth.</li> <li>• Apply spray cleaner to paper towel, do not spray directly on panel.</li> </ul>
<b>Exterior Surfaces*</b> (excluding control panel and oven door glass)	<ul style="list-style-type: none"> <li>• Soap and water</li> <li>• Mild liquid cleaner</li> <li>• Spray glass cleaner</li>   <li>• Non-abrasive plastic scrubbing pad</li> </ul>	<ul style="list-style-type: none"> <li>• DO NOT use abrasive or harsh cleaners like chlorine bleach, ammonia or oven cleaners.</li> <li>• Wash, rinse and dry with soft cloth.</li> <li>• Gently clean around the model and serial plate, too much scrubbing could remove the numbers.</li> <li>• <b>NOTE:</b> To avoid product damage, do not remove the cooktop.</li> </ul>
<b>Surface burner grates*</b> <ul style="list-style-type: none"> <li>• Light to moderate soil</li>   <li>• Heavy burned on soils</li> </ul>	<ul style="list-style-type: none"> <li>• Soap and water</li> <li>• Non-abrasive plastic scrubbing pad</li>   <li>• Dishwasher</li> <li>• Non-abrasive plastic scrubbing pad</li> <li>• Mild abrasive powdered cleanser and water</li> </ul>	<ul style="list-style-type: none"> <li>• Clean as soon as they become dirty.</li> <li>• Wash, rinse and dry well.</li>   <li>• Repeat steps of cleaning process (with items at left) as needed, until soil is completely removed.</li> <li>• Rinse thoroughly and dry.</li> </ul>

\*When the cooktop is cool, remove all spills and clean. Food spills containing acids, such as vinegar and tomato, may affect the finish.

continued on next page

# CLEANING CHART (CONT.)

PART	CLEANING METHOD	SPECIAL INSTRUCTIONS
<b>Surface burners</b>		<ul style="list-style-type: none"> <li>• See "Lift-up cooktop and surface burners" in the "Caring for your range" section.</li> </ul>
<b>Oven door glass</b> (Model SF302BSG)	<ul style="list-style-type: none"> <li>• Soap and water</li> <li>• Non-abrasive plastic scrubbing pad</li> <li>• Spray glass cleaner</li> </ul>	<ul style="list-style-type: none"> <li>• Wash, rinse and dry with soft cloth.</li> <li>• Wipe with paper towel.</li> </ul>
<b>Oven cavity</b> <ul style="list-style-type: none"> <li>• Food spills containing sugar and/or milk</li> <li>• Heavily soiled areas</li> </ul>	<ul style="list-style-type: none"> <li>• Soap and water</li> <li>• Steel wool pad</li> <li>• Commercial oven cleaner</li> </ul>	<ul style="list-style-type: none"> <li>• When oven cools, wash, rinse and dry with soft cloth.</li> <li>• Wipe with clean water and dry well.</li> <li>• Follow the directions that come with the oven cleaner. (Place newspaper on the floor to protect the floor surface.) Wipe well with clean water and dry.</li> </ul> <p><b>NOTES:</b></p> <ul style="list-style-type: none"> <li>• Use oven cleaners in a well-ventilated room.</li> <li>• <b>Do not let commercial oven cleaners contact the gasket, thermostat, or exterior surfaces of the range. This will cause damage.</b></li> <li>• For easier cleaning, you can remove the oven door. Carefully follow the instructions in the "Removing the oven door" section.</li> </ul>
<b>Oven racks</b>	<ul style="list-style-type: none"> <li>• Soap and water</li> <li>• Steel wool pad</li> </ul>	<ul style="list-style-type: none"> <li>• Wash, rinse and dry.</li> </ul>
<b>Broiler pan and grid</b>	<ul style="list-style-type: none"> <li>• Soap and water</li> <li>• Steel wool pad</li> <li>• Dishwasher</li> <li>• Solution of 1/2 cup ammonia to 1 gallon water</li> <li>• Mild abrasive cleanser or commercial oven cleaner</li> </ul>	<ul style="list-style-type: none"> <li>• Wash, rinse and dry.</li> <li>• Soak for 20 minutes, then scrub with plastic scrubbing pad.</li> </ul>

# LIFT-UP COOKTOP AND SURFACE BURNERS

1. Remove the surface burner grates.

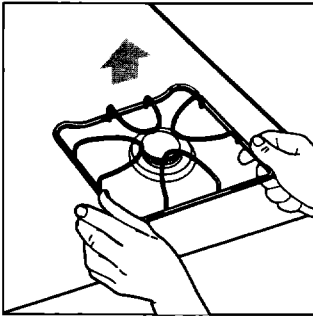

2. Lift the front of cooktop at both front corners

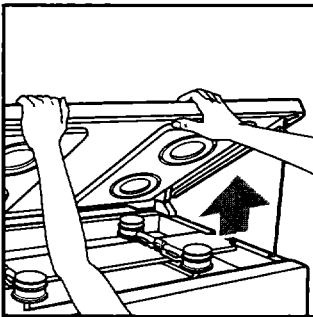

until the support rods lock into place.  
**NOTE:** Do not drop the cooktop. Damage could result to the porcelain and the cooktop frame.

3. Wipe the surface under the cooktop with warm, soapy water and a sponge. Use a soap-filled plastic scrubbing pad on heavily soiled areas.

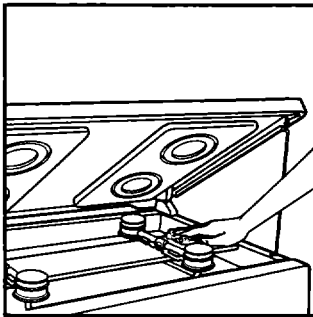

4. Wipe off the surface burners with warm, soapy water and a sponge after each use. To remove cooked-on food, soak the burners in a vinegar and water solution for 20-30 minutes. Then scrub them with a plastic scrubbing pad. (See the "Cleaning chart" section for more information.)

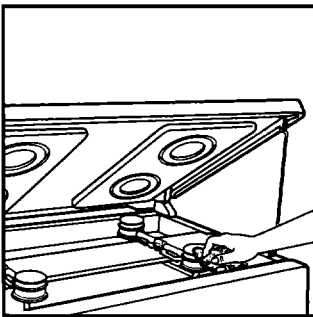

5. Check the burner flames once in a while for proper size and shape as shown.

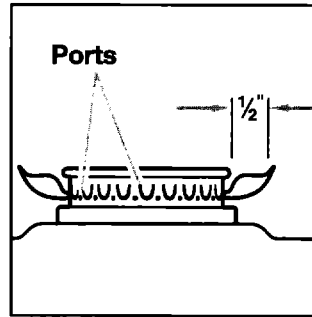

A good flame is blue in color. If flames lift away from ports, are yellow, or are noisy, turn off the burner. Allow the burner to cool and follow Step 6. If you still have a problem, contact an authorized service technician to check the air/gas mixture

or see the Installation Instructions.

6. If the ports are clogged, clean with a straight pin. **DO NOT** enlarge or distort the ports.

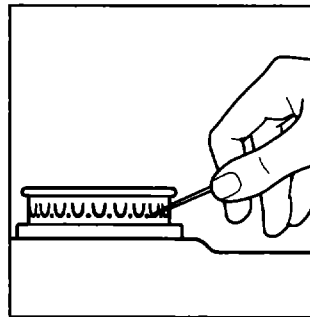

**DO NOT** use a toothpick to clean the ports. Toothpick pieces may clog the ports.

7. To lower the cooktop, lift the cooktop from both sides while pressing the support rods back to unlock them. Lower the cooktop into place.

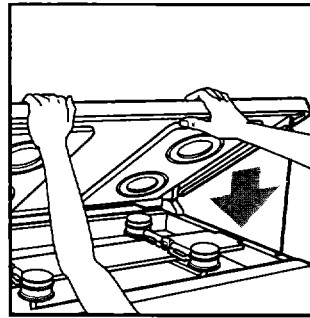

8. Replace the surface burner grates.

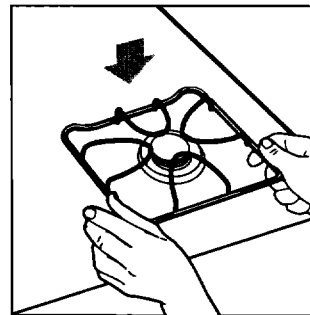

## REMOVING THE OVEN DOOR

For normal use of your range, you do not need to remove the door. However, if you find it necessary to remove the door, follow the instructions in this section.

**NOTE:** The oven door is heavy.

### Before removing the door:

1. Use a putty knife or screwdriver and insert it at the bottom corner of the door stop clip.
2. Pry door stop clip free and remove from front frame hinge slot. Take care not to scratch porcelain.
3. Repeat procedure for other door stop clip.

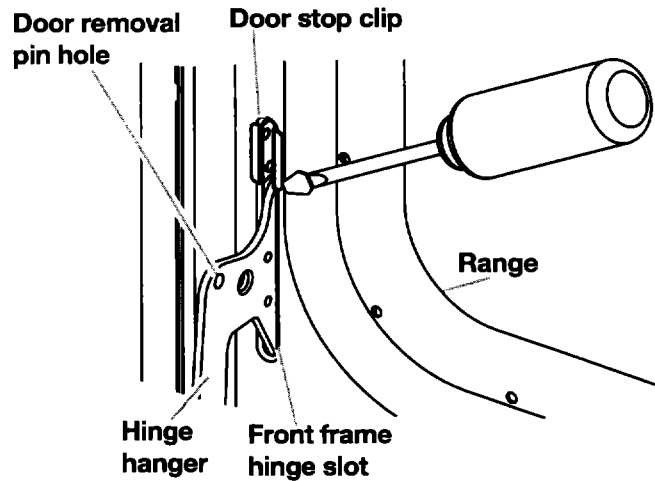

### To remove:

1. Open the oven door. Insert door removal pins, included with your range, into both hinge hangers. **Do not remove the pins while the door is removed from the range.**

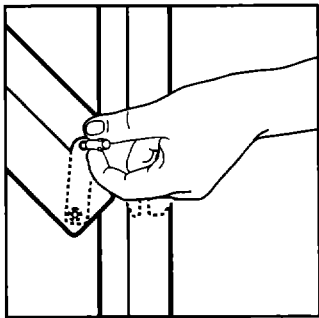

2. Carefully close the door until it rests against the door removal pins.

3. Grasp the door on the sides with your fingers on the front of the door and your thumbs on the inside surface.

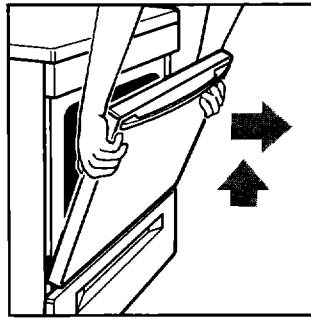

4. Pull door straight up, then toward you. Hinge hangers will slide out of front frame hinge slot.

### To replace:

**NOTE:** The door removal pins you inserted must still be in both door hinges.

1. Grasp the door on the sides with your fingers on the front of the door and your thumbs on the inside surface.

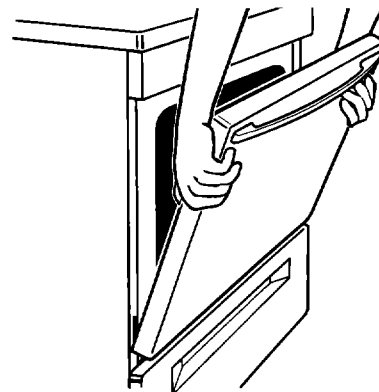

## REMOVING THE OVEN DOOR (CONT.)

**2.** Hold oven door so that the top edge of each hinge hanger is horizontal. Insert hinge hangers into the front frame hinge slots.

**3.** Rotate top of door toward range. Slide hinge hangers down onto front frame support pins.

**NOTE:** Make sure the hinge hangers are fully seated and engaged on the support pins.

**4.** Insert the door stop clip with the angular surface at the top of the frame hinge slot, then push in the bottom of the clip until flanges are flush with the front frame.

**5.** Open the door completely and remove the door removal pins. Save door removal pins for future use.

**6.** Close the door.

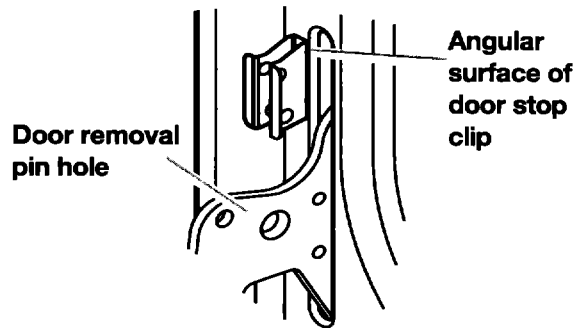
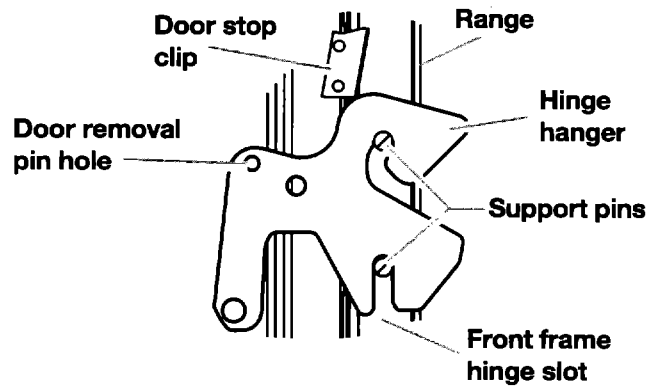

## REMOVING THE OVEN BOTTOM

You can remove the panel in the oven bottom for cleaning.

### To remove:

1. Let oven cool.
2. Remove the oven racks.
3. Remove the 2 hold-down screws at the rear of the oven. If the screws are too tight to remove by hand, use a screwdriver.

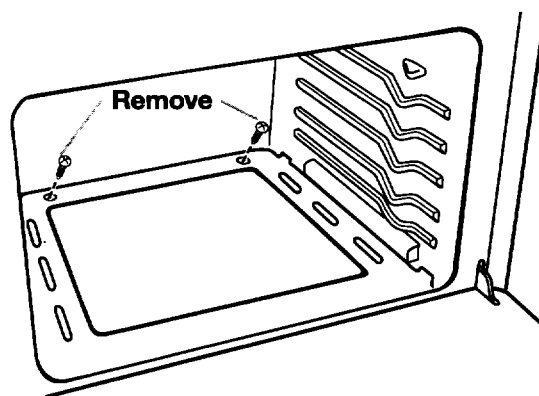

4. Place your fingers in the slots in the bottom panel and lift the rear of the panel up and back until the lip at the front of the panel is clear of the front frame of the oven cavity.
5. Lift the bottom up and out.

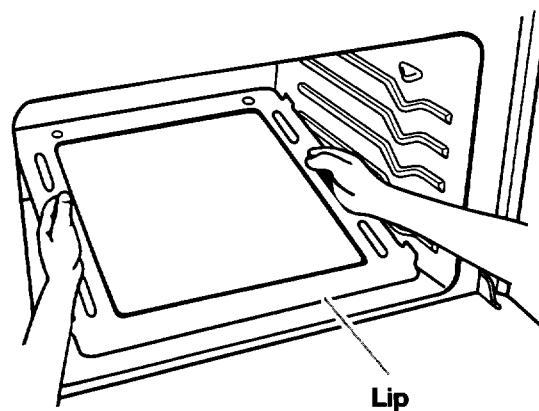

### To replace:

Reverse the steps above.

# TROUBLESHOOTING

Most cooking problems often are caused by little things you can find and fix without tools of any kind. Check the lists below and on the next page before calling for assistance or service. If you still need help, see "Requesting Assistance or Service" on page 25.

## RANGE DOES NOT WORK

PROBLEM	CAUSE
Nothing works	<ul style="list-style-type: none"><li>● The range is not plugged into a properly grounded outlet (120v polarized).</li><li>● The range is not properly connected to the gas supply. Contact an authorized service technician to reconnect the range to the gas supply. (See the Installation Instructions.)</li><li>● You have blown a household fuse or tripped a circuit breaker.</li></ul>

## OVEN/BROILER BURNER

PROBLEM	CAUSE
The oven does not work	<ul style="list-style-type: none"><li>● You have not turned the oven temperature control knob to a temperature setting. (See "Adjusting the oven temperature control" section.)</li><li>● The main or regulator gas shutoff valve is in the off position. (See the Installation Instructions.)</li></ul>
The burner fails to light	<ul style="list-style-type: none"><li>● The ignitor is broken. Contact an authorized service technician to replace it.</li><li>● You have blown a household fuse or tripped a circuit breaker.</li></ul>
The burner flames lift away from the ports, are yellow, or are noisy	<ul style="list-style-type: none"><li>● The air/gas mixture is incorrect. Contact an authorized service technician to check the air/gas mixture or see the Installation Instructions.</li></ul>

## SURFACE BURNERS

PROBLEM	CAUSE
The burner fails to light	<ul style="list-style-type: none"><li>● The control knob is not set correctly. Push in the control knobs before turning them. Make sure the control knob is turned to the Light position. (See page 6.)</li><li>● You have blown a household fuse or tripped a circuit breaker.</li><li>● The burner ports may be clogged. Clean them with a straight pin. (See page 19.)</li></ul>
The burner flames are uneven	<ul style="list-style-type: none"><li>● The burner ports may be clogged. Clean them with a straight pin. (See page 19.)</li></ul>
The burner flames lift off the ports, are yellow, or are noisy when turned off	<ul style="list-style-type: none"><li>● The burner needs cleaning. (See pages 18 and 19.)</li><li>● The air/gas mixture is incorrect. Contact an authorized service technician to check the air/gas mixture or see the Installation Instructions.</li></ul>
The burner makes a popping noise when on	<ul style="list-style-type: none"><li>● The burner is wet from washing. Let it dry.</li></ul>

continued on next page

# COOKING RESULTS

<b>PROBLEM</b>	<b>SOLUTION</b>
Cookware not level on cooktop (Check to see if liquids are level in cookware)	<ul style="list-style-type: none"> <li>● Level the range. (See the Installation Instructions.)</li> <li>● Use cookware with a flat bottom.</li> </ul>
Excessive heat on cooktop in areas around cookware	<ul style="list-style-type: none"> <li>● Choose cookware the same size or slightly larger than the burner flame.</li> </ul>
The oven temperature seems too low or too high	<ul style="list-style-type: none"> <li>● Adjust the oven temperature control. (See "Adjusting the oven temperature control" section.)</li> </ul>
Slow baking or roasting	<ul style="list-style-type: none"> <li>● Increase baking or roasting time.</li> <li>● Increase temperature 25° F.</li> <li>● Preheat oven to selected temperature before placing food in when preheating is recommended.</li> <li>● Choose bakeware that will allow 2 inches of air space around all sides.</li> <li>● Open oven door to check food when timer signals shortest time suggested in recipe.</li> <li>● Oven peeking can make cooking times longer.</li> </ul>
Baked items too brown on bottom	<ul style="list-style-type: none"> <li>● Preheat oven to selected temperature before placing food in oven.</li> <li>● Choose bakeware that will allow 2 inches of air space around all sides.</li> <li>● Position rack higher in oven.</li> <li>● Decrease oven temperature 15° to 25° F.</li> </ul>
Unevenly baked items	<ul style="list-style-type: none"> <li>● Level the range.</li> <li>● Bake in center of oven with 2 inches of space around each pan.</li> <li>● Check to make sure batter is level in pan.</li> </ul>
Crust edge browns before pie is done	<ul style="list-style-type: none"> <li>● Shield edge with foil.</li> </ul>

If none of these items are causing your problem, see "Requesting Assistance or Service" on page 25.



# REQUESTING ASSISTANCE OR SERVICE

To avoid unnecessary service calls, please check the "Troubleshooting" section. It may save you the cost of a service call. If you still need help, follow the instructions below.

## IF YOU NEED ASSISTANCE OR SERVICE

Call our Consumer Assistance Center at



**1-616-923-7113. Our consultants are available to assist you.**

When calling:

Please know the purchase date, and the complete model and serial number of your appliance (see the "A Note to You" section). This information will help us better respond to your request.

**Our consultants provide assistance with:**

- Features and specifications on our full line of appliances
- Installation information
- Use and maintenance procedures

- Accessory and repair parts sales
- Specialized customer assistance (Spanish speaking, hearing impaired, limited vision, etc.)
- Referrals to local dealers, service companies, and repair parts distributors

To locate an authorized service company in your area, you can also look in your telephone directory Yellow Pages.

## IF YOU NEED REPLACEMENT PARTS

If you need to order replacement parts, we recommend that you only use FSP® factory authorized parts. FSP replacement parts will fit right and work right, because they are made to the same exacting specifications used to build every new Roper® appliance.

To locate FSP replacement parts in your area, call our Consumer Assistance Center telephone number or your nearest authorized service center.

## FOR FURTHER ASSISTANCE

If you need further assistance, you can write to us with any questions or concerns at:

Roper Brand Home Appliances  
Consumer Assistance Center  
c/o Correspondence Dept.  
2000 North M-63  
Benton Harbor, MI 49022-2692

Please include a daytime phone number in your correspondence.

# INDEX

TOPIC	PAGE	TOPIC	PAGE
ANTI-TIP BRACKET .....	16	LIFT-UP COOKTOP .....	19
ASSISTANCE .....	25	MODEL AND SERIAL NUMBER .....	2
<b>BAKING</b>		<b>OVEN</b>	
Aluminum foil .....	9	Bottom .....	22
Bakeware .....	9	Door .....	20, 21
Pans .....	8, 12	<b>OVEN TEMPERATURE</b>	
Racks .....	8, 12	Adjusting .....	13
Setting cycle .....	12	Setting .....	12
Tips .....	12	<b>OVEN VENT</b> .....	15
<b>BROILING</b>		<b>PANS</b> .....	8, 12
Broiler .....	14	<b>PARTS</b> .....	5
Grid .....	14	<b>RACKS</b> .....	8, 12
Guidelines .....	15	<b>ROASTING</b>	
Pan .....	14	Pans .....	8, 12
Setting cycle .....	14	Racks .....	8, 12
<b>CLEANING</b>		Setting cycle .....	12
Broiler pan and grid .....	18	Tips .....	12
Control knobs .....	17	<b>SAFETY</b> .....	3, 4
Control panel .....	17	<b>SERVICE</b> .....	25
Exterior surfaces .....	17	<b>SURFACE BURNERS</b>	
Oven cavity .....	18	Control knobs .....	6, 17
Oven door glass .....	18	Control setting guide .....	6
Oven racks .....	18	Power failure .....	7
Surface burners .....	18, 19	Surface burner markers .....	5
Surface burner grates .....	17	<b>TROUBLESHOOTING</b> .....	23, 24
<b>CONTROL PANEL</b>		<b>WARRANTY</b> .....	28
Burner heat settings .....	6		
Control knobs .....	6		
Surface burner markers .....	5		
<b>COOKWARE</b>			
Canning .....	7		
Materials .....	7		
Tips .....	7		
<b>ELECTRONIC TIME-OF-DAY CLOCK/TIMER</b> (Model FGP335G)			
Clock .....	10		
Display .....	10		
Timer .....	11		
<b>FEATURES</b> .....	5		

# WARRANTY

## ROPER® GAS RANGE

<b>LENGTH OF WARRANTY</b>	<b>WE WILL PAY FOR</b>
<b>FULL ONE-YEAR WARRANTY</b> FROM DATE OF PURCHASE	FSP® replacement parts and repair labor to correct defects in materials or workmanship. Service must be provided by an authorized Roper service company.
<b>WE WILL NOT PAY FOR</b>	
<p><b>A. Service calls to:</b></p> <ol style="list-style-type: none"> <li>1. Correct the installation of your range.</li> <li>2. Instruct you how to use your range.</li> <li>3. Replace house fuses or correct house wiring or plumbing.</li> <li>4. Replace owner-accessible light bulbs.</li> </ol> <p><b>B. Repairs when your range is used in other than normal, single-family household use.</b></p> <p><b>C. Pickup and delivery.</b> Your range is designed to be repaired in the home.</p> <p><b>D. Damage to your range caused by accident, misuse, fire, flood, acts of God, or use of products not approved by us.</b></p> <p><b>E. Repairs to parts or systems resulting from unauthorized modifications made to the appliance.</b></p>	

3/98

**THIS ROPER APPLIANCE IS WARRANTED BY WHIRLPOOL CORPORATION. UNDER NO CIRCUMSTANCES SHALL IT BE LIABLE UNDER THIS WARRANTY FOR INCIDENTAL OR CONSEQUENTIAL DAMAGES.** Some states do not allow the exclusion or limitation of incidental or consequential damages, so this exclusion or limitation may not apply to you. This warranty gives you specific legal rights, and you may also have other rights which vary from state to state.

**Outside the United States, a different warranty may apply. For details, please contact your authorized Roper dealer.**

If you need service, first see the "Troubleshooting" section of this book. After checking "Troubleshooting," additional help can be found by checking the "Requesting Assistance or Service" section, or by calling 1-616-923-7113 from anywhere in the U.S.A.